

MICROVALVOLE - MICROVALVES

V serie - series



Le microvalvole della serie "V" sono dei distributori pneumatici a 3/2 a comando meccanico con funzione n.c. e n.a.. che con appositi attuatori diventano delle valvole ad azionamento manuale con la possibilità di eseguire funzioni 5/2 e 5/3 mono, bistabili, centri chiusi, centri aperti e centri in pressione.

Di serie le valvole sono provviste di attacchi rapidi per tubo 4 posizionati sul fondo del corpo. A richiesta (sostituendo nel codice il numero 4 con il numero 5) vengono fornite con attacchi filettati M5, aggiungendo nel codice la lettera L, gli attacchi per tubo 4 o M5 vengono posizionati a lato del corpo.

"V" series microvalve are 3/2 mechanical pilot valves available in the normally open or normally closed versions. With specific brackets, levers or buttons they can be used like 5/2 or 5/3 (closed center or pressurized centers) valves in order to pilot bigger valves or control signals.

Standard version is available with 4 mm tube fittings on the bottom of the body.

On request (changing the final letter of the order code) they can be supplied with ports M5 and adding L, ports can be supplied on the side of the body.

Informazioni tecniche - Technical informations

Fluido: aria filtrata 25 µm lubrificata o non lubrificata (se lubrificata usare olio per circuiti pneumatici).

Fluid: filtered air 25 µm lubricated or not lubricated (when lubricated use oil for pneumatic circuits).

Temperatura di esercizio - Temperature range: -10 °C ÷ +60 °C

Pressione di esercizio - Working pressure: 2 ÷ +10 bar (0,2 ÷ 1 MPa)

Portata nominale - Nominal flow rate: 90 NI/min

Forza di azionamento - Actuating force: 6 N

VP32C4.

Con attacchi ad innesto rapido per tubo Ø4
Automatic fittings Ø4 tube

Massa - Mass: 40 g

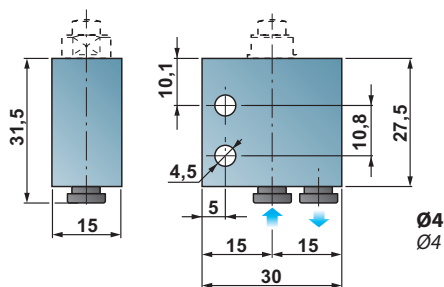

VP32C4

Versione standard (con attacchi sotto)
Standard version (with ports on the bottom)

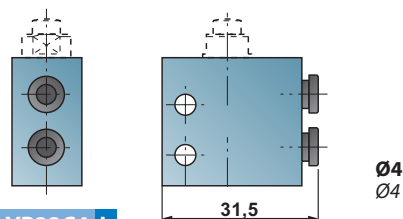

VP32C4 L

Versione a richiesta con attacchi laterali
On request (with ports on the side)

VP32C5.

Con attacchi filettati M5
M5 threaded ports

Massa - Mass: 40 g

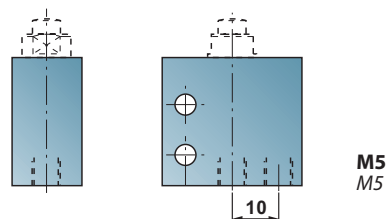

VP32C 5

Versione a richiesta con attacchi filettati sul fondo
On request with threaded ports on the bottom

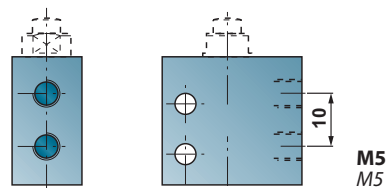

VP32C 5L

Versione a richiesta con attacchi filettati laterali
On request with threaded ports on the side

VP ..

Microvalvole 3/2 a puntale
3/2 microvalves with push button

VP32C4

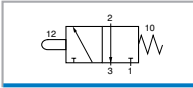

VP32A4

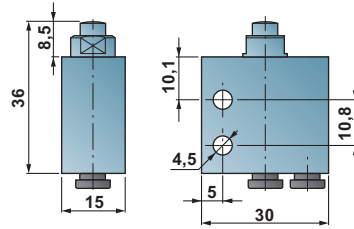
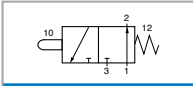

Massa - Mass: 45 g

VPP ..

Microvalvole 3/2 a puntale passaparte
3/2 microvalves with bulkhead push button

VPP32C4

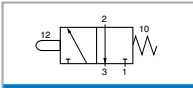

VPP32A4

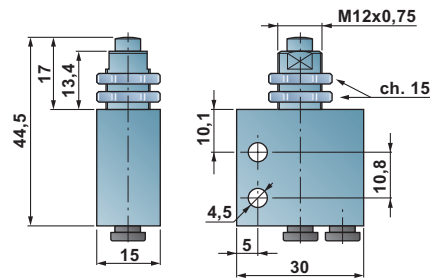
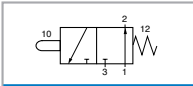

Massa - Mass: 45 g

VR ..

Microvalvole 3/2 a leva rotolo
3/2 microvalves with roller lever

VR32C4

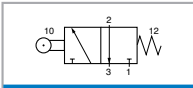

VR32A4

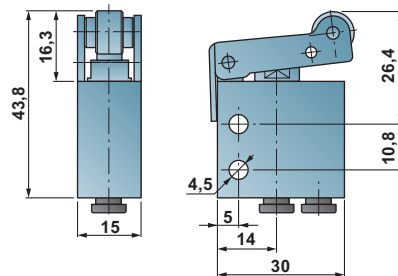
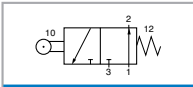

Massa - Mass: 60 g

VU ..

Microvalvole 3/2 a leva unidirezionale
3/2 microvalves with uni-directional lever

VU32C4

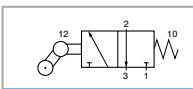

VU32A4

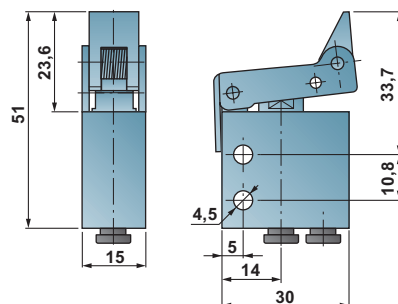
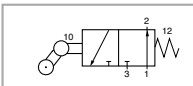

Massa - Mass: 60 g

VT ..

Microvalvole a tasto manuale
Microvalves with manual push button



Massa - Mass: 45 g

Di serie la valvola viene fornita con il tasto nero; a richiesta può avere il tasto verde, giallo o rosso aggiungendo alla fine del codice rispettivamente V, G, R (Esempio: VT324CR = valvola con tasto ROSSO).

Standard version is supplied with black lever colour. On request it's available in green, yellow or red colour. It's enough to add at the end of the code the letters V, G, R (Example: VT324CR = valve with RED push button).

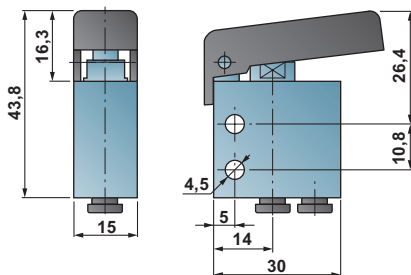

VT32C4

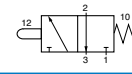

VT32A4

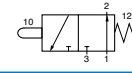

VT22C4

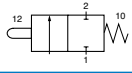

VL32L5

Microvalvola a leva in testa
Microvalve with top lever



Massa - Mass: 60 g

Materiali e dotazioni standard - Materials and standard accessories

Materiale corpo: ... ottone nichelato Material of the body: nickel plated brass

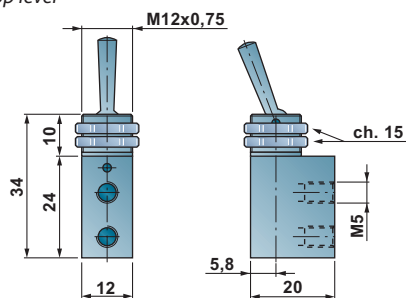

VL32L5

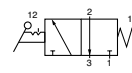

VB3 ..

Microvalvola a puntale con interfaccia per attuatore da pannello
Microvalve completed with brackets



Massa - Mass: 40 g

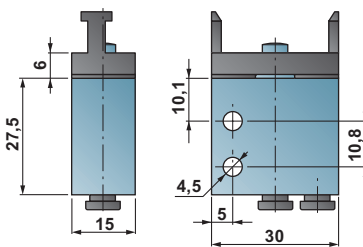

VB32C4

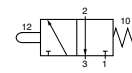

VB32A4

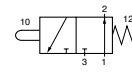

VB5 ..

Microvalvole a puntale con interfaccia per attuatore da pannello
Microvalves completed with brackets



Massa - Mass: 80 g

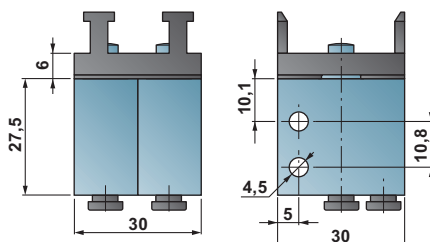

VB52M4

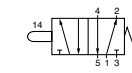

VB53A4

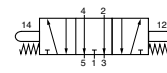

VB53P4

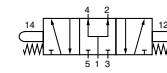

ATTUATORI PER MICROVALVOLE - ACTUATORS FOR MICROVALVES



Gli attuatori da pannello sono dei dispositivi per l'azionamento manuale delle microvalvole adatti ad essere installati in quadri di comando delle macchine.

Nella tabella che segue, viene specificata il tipo di valvola da abbinare all'attuatore scelto per ottenere la funzione desiderata.

Valves for Panel Mounting are valves of "V" series with lever or button device in order to be mounted on control panels of the automatic machines.
The following table is useful to understand which valve to choose in the catalogue for the specific need.

Esempio di fissaggio a parete - Fixing example

Distanze minime praticabili tra i fori sul pannello per attuatori:
Minimum distances between holes on the panel to actuators:

PP. **SC...** **SL...** **SCH**

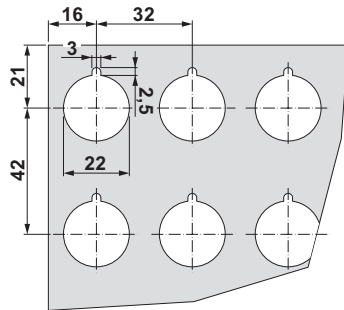

Spessore massimo del pannello - Maximum panel thickness: 9,5 mm

Distanze minime praticabili tra i fori sul pannello per attuatori:
Minimum distances between holes on the panel to actuators:

PFR **PBR**

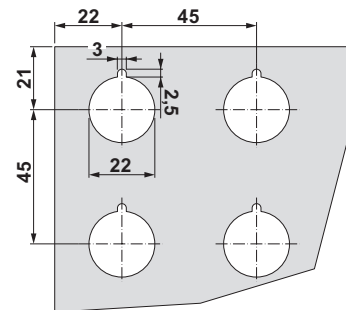

Pulsante protetto monostabile
Monostable protected push-button

PP.

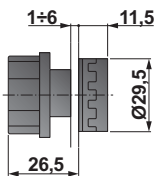

Codice Code	Descrizione Description	Colore Colour
PPN	Monostabile - Monostable	NERO - Black
PPR	Monostabile - Monostable	ROSSO - Red
PPB	Monostabile - Monostable	BIANCO - White
PPV	Monostabile - Monostable	VERDE - Green

Selettore leva lunga
Long lever selector

SL...

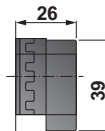

Codice Code	Funzione Function	Descrizione Description	Colore Colour
SL01B	0 1	Bistabile - Bistable	NERO - Black
SL01M	0 ← 1	Monostabile - Monostable	NERO - Black
SL102B	2 0 1	Stabile - Stable	NERO - Black
SL102M	2 → 0 ← 1	Monostabile - Monostable	NERO - Black

Fungo Ø40
Ø40 mushroom

PBR

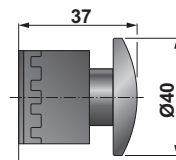

Codice Code	Funzione Function	Descrizione Description	Colore Colour
PBR		Sblocco a rotazione Turn to unlock	ROSSO Red

Selettore leva corta
Short lever selector

SC...

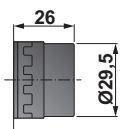

Codice Code	Funzione Function	Descrizione Description	Colore Colour
SC01B	0 1	Bistabile - Bistable	NERO - Black
SC01M	0 ← 1	Monostabile - Monostable	NERO - Black
SC102B	2 0 1	Stabile - Stable	NERO - Black
SC102M	2 → 0 ← 1	Monostabile - Monostable	NERO - Black

Selettore a chiave
Key selector

SCH

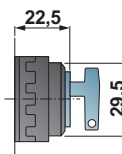

Codice Code	Funzione Function	Descrizione Description	Colore Colour
SCH	0 1	Bistabile - Bistable	NERO - Black

Fungo Ø40 monostabile
Monostable Ø40 mushroom

PFR

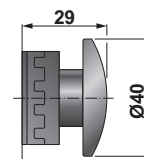

Codice Code	Funzione Function	Descrizione Description	Colore Colour
PFR		Monostabile assiale Axial monostable	ROSSO Red

Combinazioni per attuatori da pannello - Combination for actuators panel

**COMBINAZIONI PER PULSANTE PROTETTO
COMBINATION FOR PROTECTED PUSH BUTTON**

VALVOLA VALVE	ATTUATORE ACTUATOR	FUNZIONE FUNCTION
VB32C4	+ PP.	
VB32A4	+ PP.	
VB52M4	+ PP.	

**COMBINAZIONI PER SELETTORE LEVA CORTA
COMBINATION FOR SHORT LEVER SELECTOR**

VALVOLA VALVE	ATTUATORE ACTUATOR	FUNZIONE FUNCTION
VB32C4	+ SC01M	
VB32A4	+ SC01M	
VB32C4	+ SC01B	
VB32A4	+ SC01B	
VB52M4	+ SC01M	
VB52M4	+ SC01B	
VB53A4	+ SC102M	
VB53P4	+ SC102M	
VB53A4	+ SC102B	
VB53P4	+ SC102B	

**COMBINAZIONI PER SELETTORE LEVA LUNGA
COMBINATION FOR LONG LEVER SELECTOR**

VALVOLA VALVE	ATTUATORE ACTUATOR	FUNZIONE FUNCTION
VB32C4	+ SL01M	
VB32A4	+ SL01M	
VB32C4	+ SL01B	
VB32A4	+ SL01B	
VB52M4	+ SL01M	
VB52M4	+ SL01B	
VB53A4	+ SL102M	
VB53P4	+ SL102M	
VB53A4	+ SL102B	
VB53P4	+ SL102B	

**COMBINAZIONI PER SELETTORE A CHIAVE BISTABILE
COMBINATION FOR BISTABLE KEY SELECTOR**

VALVOLA VALVE	ATTUATORE ACTUATOR	FUNZIONE FUNCTION
VB32C4	+ SCH	
VB32A4	+ SCH	
VB52M4	+ SCH	

**COMBINAZIONI PER FUNGO Ø40, SBLOCCO A ROTAZIONE
COMBINATION FOR Ø40 PALM, ROTATION UNBLOCK**

VALVOLA VALVE	ATTUATORE ACTUATOR	FUNZIONE FUNCTION
VB32C4	+ PBR	
VB32A4	+ PBR	
VB52M4	+ PBR	

**COMBINAZIONI PER FUNGO Ø40 MONOSTABILE ASSIALE
COMBINATION FOR Ø40 MUSHROOM AXIAL MONOSTABLE**

VALVOLA VALVE	ATTUATORE ACTUATOR	FUNZIONE FUNCTION
VB32C4	+ PFR	
VB32A4	+ PFR	
VB52M4	+ PFR	

Esempio di combinazione - Example of combination

Esempio di combinazione tra la microvalvola VB53P4 con funzione 5/3 a centri in pressione e l'attuatore da pannello SC102M a leva che aziona la microvalvola meccanica sulle tre posizioni con riposizionamento al centro (monostabile).

Example of combination between VB53P4 valve with 5/3 working with pressurized centres and SC102M actuator for panel mounting that operate on the mechanical microvalve on 3 positions with central return (monostable).

