

## VALVOLE AD AZIONAMENTO PNEUMATICO - PNEUMATIC OPERATED VALVES

**PF** serie - series

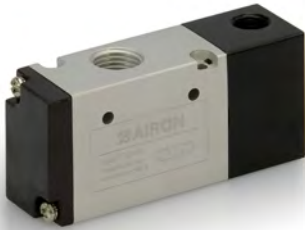

Le valvole a comando pneumatico della serie "PF" utilizzano la stessa affidabile meccanica della serie "EF", come quest'ultime sono assemblabili in batteria. Per una maggior compattezza della batteria gli attacchi di pilotaggio sono stati posizionati sullo stesso piano degli utilizzi.

"PF" pneumatic pilot valves are very similar to the "EF" series except for the pilot port that is located on the side of the A and B ports in order to give compactness. They can be used with the electrical pilot too in order to allow a complete mix of valve when they are assembled in a manifold base.

### Informazioni tecniche - Technical informations

**Fluido:** aria filtrata 25 µm lubrificata o non lubrificata (se lubrificata usare olio per circuiti pneumatici).  
*Fluido:* filtered air 25 µm lubricated or not lubricated (when lubricated use oil for pneumatic circuits).

**Temperatura di esercizio** - Temperature range: - 5 °C ÷ + 60 °C

**Pressione di esercizio** - Working pressure: 1,5 ÷ 8 bar (0,15 ÷ 0,8 MPa)

**Pressione minima di pilotaggio** - Minimum pilot pressure: **Vedere diagrammi sotto** - See diagrams below

### Come ordinare - Code example

**Valvola G1/4 taglia 22 3/2 normalmente aperta a comando pneumatico ritorno a molla.**

*Valve G1/4 size 22 3/2 normally open with pneumatic pilot spring return.*

**PF32M4A**

### DIAGRAMMI PRESSIONE MINIMA PILOTAGGIO - MINIMAL PILOT PRESSURE DIAGRAM

**Valvole pneumatiche monostabili 3/2 serie "PF"**  
*Pneumatic monostable valves 3/2, "PF" series*

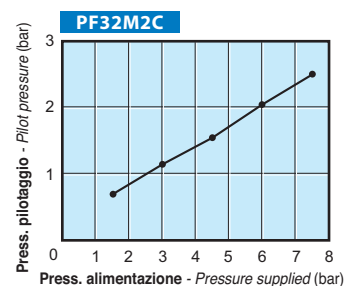
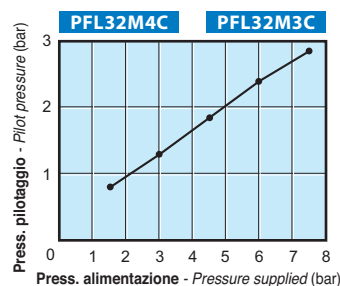
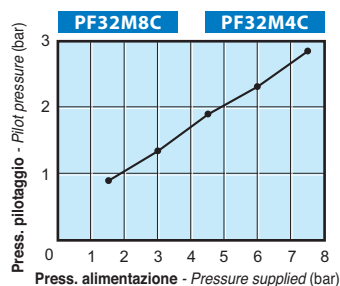
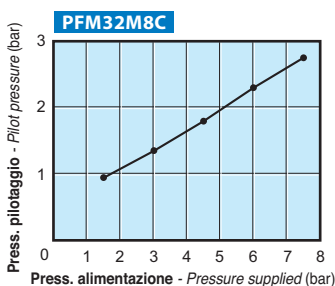

**Valvole pneumatiche monostabili 5/2 serie "PF"**  
*Pneumatic monostable valves 5/2, "PF" series*

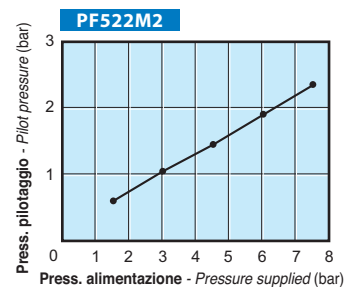
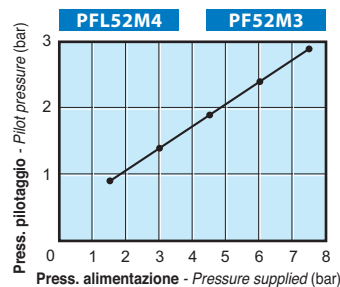
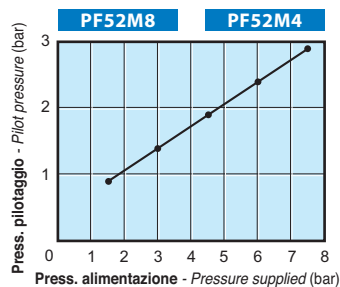
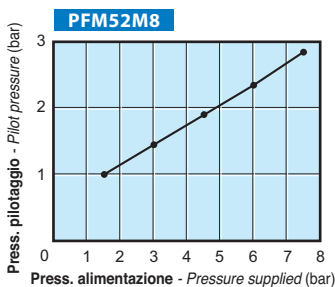

**VALVOLA A COMANDO PNEUMATICO 3/2 MONOSTABILE - PNEUMATIC OPERATED VALVE 3/2 MONOSTABLE**

N.A. / N.O.

N.C. / N.C.

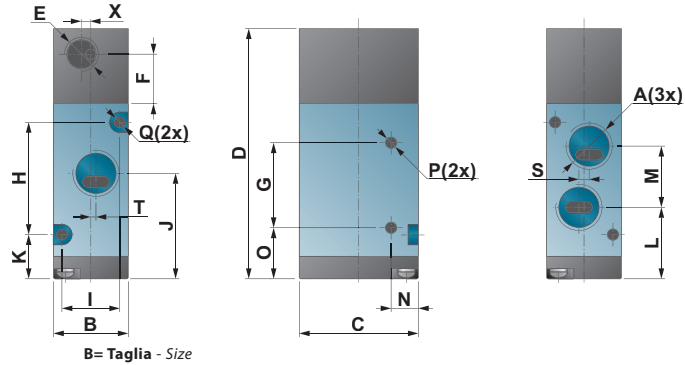
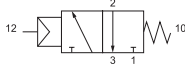
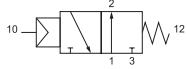

| Codice - Code |             | Taglia Size |    |    |    |      |      |    |    |    |    |    |      |    |    |       |       | N.A. |   | N.C. |      | Portata Flow (Nl/min) | Massa Mass (g) |      |     |
|---------------|-------------|-------------|----|----|----|------|------|----|----|----|----|----|------|----|----|-------|-------|------|---|------|------|-----------------------|----------------|------|-----|
| N.A. / N.O.   | N.C. / N.C. | A           | B  | C  | D  | E    | F    | G  | H  | I  | K  | L  | M    | N  | O  | P     | Q     | S    | X | J    | T    |                       |                | J    | T   |
| PFM32M8A      | PFM32M8C    | G1/8        | 18 | 27 | 58 | G1/8 | 13,5 | 21 | 19 | 13 | 13 | 14 | 16   | 8  | 12 | Ø 3,3 | Ø 3,3 | 2    | 2 | 23   | -1   | 22                    | 1              | 670  | 60  |
| PF32M8A       | PF32M8C     | G1/8        | 22 | 35 | 74 | G1/8 | 15,5 | 25 | 33 | 17 | 12 | 19 | 18   | 8  | 16 | Ø 3,3 | Ø 3,2 | 3    | 2 | 31   | -1,5 | 26                    | 1,5            | 790  | 140 |
| PF32M4A       | PF32M4C     | G1/4        | 22 | 35 | 75 | G1/8 | 15,5 | 25 | 33 | 17 | 13 | 19 | 18   | 8  | 16 | Ø 3,3 | Ø 3,2 | 3    | 2 | 31   | -1,5 | 28                    | 1,5            | 840  | 140 |
| PFL32M4A      | PFL32M4C    | G1/4        | 27 | 40 | 83 | G1/8 | 17   | 30 | 35 | 20 | 15 | 21 | 24   | 10 | 18 | Ø 4,3 | Ø 4,3 | -    | 2 | 33   | -2   | 32                    | 2              | 1230 | 200 |
| PF32M3A       | PF32M3C     | G3/8        | 27 | 40 | 82 | G1/8 | 17   | 30 | 35 | 20 | 15 | 21 | 24   | 11 | 18 | Ø 4,3 | Ø 4,3 | -    | 2 | 33   | -2   | 32                    | 2              | 1520 | 200 |
| PF32M2A       | PF32M2C     | G1/2        | 34 | 50 | 97 | G1/8 | 16   | 51 | 41 | 27 | 19 | 23 | 31,5 | 13 | 16 | Ø 4,3 | Ø 4,3 | -    | - | 42   | -2   | 36                    | 2              | 3500 | 360 |

**VALVOLA A COMANDO PNEUMATICO 3/2 BISTABILE - PNEUMATIC OPERATED VALVE 3/2 BISTABLE**

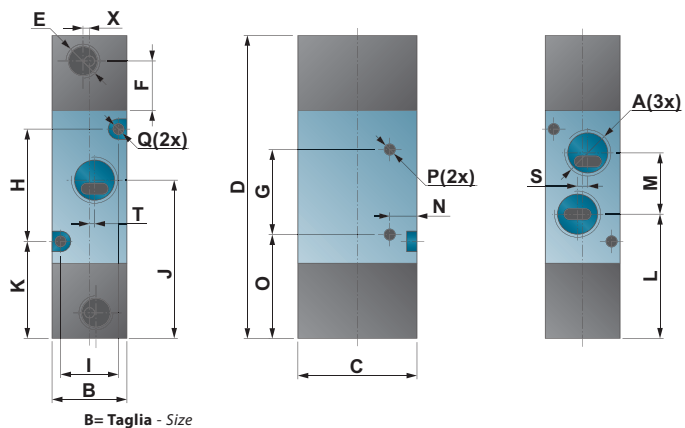
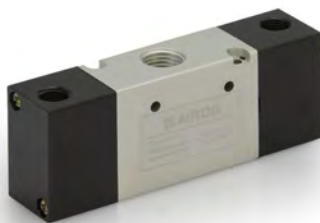
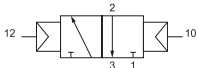

| Codice - Code |   | Taglia Size |    |    |     |      |      |    |    |    |    |    |    |      |    |    |       | Portata Flow (Nl/min) |   | Massa Mass (g) |   |  |      |     |
|---------------|---|-------------|----|----|-----|------|------|----|----|----|----|----|----|------|----|----|-------|-----------------------|---|----------------|---|--|------|-----|
| A             | B | C           | D  | E  | F   | G    | H    | I  | J  | K  | L  | M  | N  | O    | P  | Q  | S     | T                     | X |                |   |  |      |     |
| PFM32P8       |   | G1/8        | 18 | 27 | 73  | G1/8 | 13,5 | 21 | 19 | 13 | 35 | 25 | 27 | 16   | 8  | 26 | Ø 3,3 | Ø 3,3                 | 2 | 1              | 2 |  | 670  | 80  |
| PF32P8        |   | G1/8        | 22 | 35 | 92  | G1/8 | 15,5 | 25 | 33 | 17 | 48 | 29 | 36 | 18   | 8  | 33 | Ø 3,3 | Ø 3,2                 | 3 | 1,5            | 2 |  | 790  | 160 |
| PF32P4        |   | G1/4        | 22 | 35 | 92  | G1/8 | 15,5 | 25 | 33 | 17 | 46 | 27 | 36 | 18   | 8  | 30 | Ø 3,3 | Ø 3,2                 | 3 | 1,5            | 2 |  | 840  | 160 |
| PFL32P4       |   | G1/4        | 27 | 40 | 96  | G1/8 | 17   | 30 | 35 | 20 | 48 | 31 | 36 | 24   | 11 | 33 | Ø 4,3 | Ø 4,3                 | - | 2              | 2 |  | 1230 | 240 |
| PF32P3        |   | G3/8        | 27 | 40 | 96  | G1/8 | 17   | 30 | 35 | 20 | 48 | 31 | 36 | 24   | 11 | 33 | Ø 4,3 | Ø 4,3                 | - | 2              | 2 |  | 1520 | 240 |
| PF32P2        |   | G1/2        | 34 | 50 | 112 | G1/8 | 16   | 51 | 41 | 27 | 55 | 19 | 40 | 31,5 | 13 | -  | Ø 4,3 | Ø 4,3                 | - | 2              | - |  | 3500 | 420 |

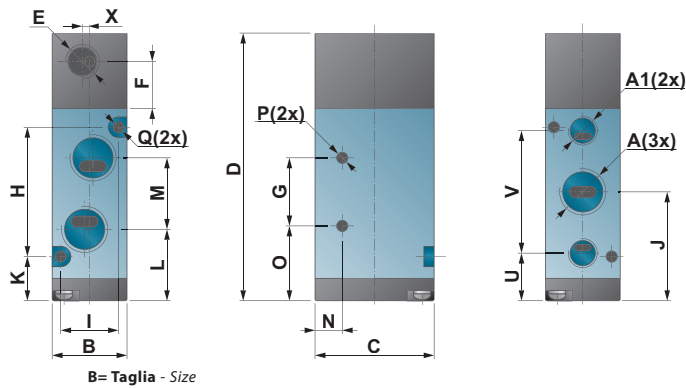
**VALVOLA A COMANDO PNEUMATICO 5/2 MONOSTABILE - PNEUMATIC OPERATED VALVE 5/2 MONOSTABLE**

| Codice - Code | Taglia<br>Size |      |    |    |     |      |      |    |    |    |    |    |    |    |     |    |       | Portata<br>Flow<br>(NI/min) | Massa<br>Mass<br>(g) |    |   |      |     |
|---------------|----------------|------|----|----|-----|------|------|----|----|----|----|----|----|----|-----|----|-------|-----------------------------|----------------------|----|---|------|-----|
|               | A              | A1   | B  | C  | D   | E    | F    | G  | H  | I  | J  | K  | L  | M  | N   | O  | P     |                             |                      | Q  | U | V    | X   |
| PFM52M8       | G1/8           | G1/8 | 18 | 27 | 69  | G1/8 | 13,5 | 14 | 30 | 13 | 28 | 13 | 20 | 16 | 4   | 21 | ∅ 3,3 | ∅ 3,3                       | 14                   | 28 | 2 | 630  | 70  |
| PF52M8        | G1/8           | G1/8 | 22 | 35 | 80  | G1/8 | 15,5 | 20 | 38 | 17 | 32 | 13 | 23 | 18 | 7   | 22 | ∅ 4,3 | ∅ 3,2                       | 14                   | 36 | 2 | 1240 | 140 |
| PF52M4        | G1/4           | G1/8 | 22 | 35 | 80  | G1/8 | 15,5 | 20 | 38 | 17 | 31 | 13 | 21 | 21 | 7   | 22 | ∅ 4,3 | ∅ 3,2                       | 14                   | 36 | 2 | 1040 | 140 |
| PFL52M4       | G1/4           | G1/4 | 27 | 40 | 98  | G1/8 | 17   | 24 | 50 | 20 | 40 | 15 | 29 | 22 | 6,5 | 28 | ∅ 4,3 | ∅ 4,3                       | 18                   | 45 | 2 | 1250 | 240 |
| PF52M3        | G3/8           | G1/4 | 27 | 40 | 98  | G1/8 | 17   | 24 | 50 | 20 | 40 | 15 | 28 | 24 | 6,5 | 28 | ∅ 4,3 | ∅ 4,3                       | 17                   | 45 | 2 | 1420 | 240 |
| PF52M2        | G1/2           | G1/2 | 34 | 50 | 129 | G1/8 | 16   | 28 | 72 | 27 | 57 | 21 | 39 | 36 | 8   | 43 | ∅ 5,5 | ∅ 4,3                       | 26                   | 63 | - | 3150 | 460 |

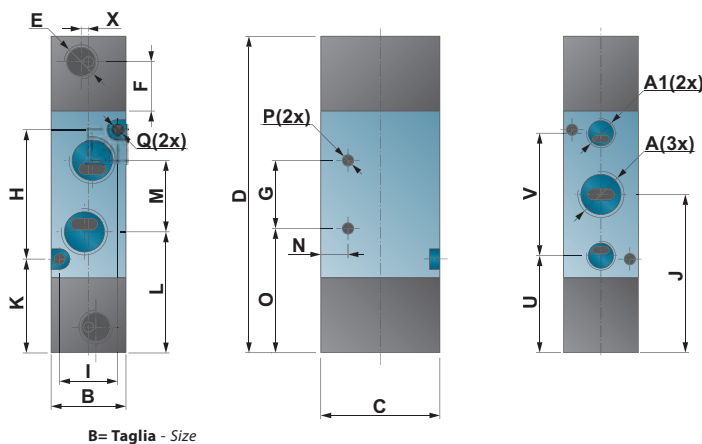
**VALVOLA A COMANDO PNEUMATICO 5/2 BISTABILE - PNEUMATIC OPERATED VALVE 5/2 BISTABLE**

| Codice - Code | Taglia<br>Size |      |    |    |     |      |      |    |    |    |    |    |    |    |     |      |       | Portata<br>Flow<br>(NI/min) | Massa<br>Mass<br>(g) |    |   |      |     |
|---------------|----------------|------|----|----|-----|------|------|----|----|----|----|----|----|----|-----|------|-------|-----------------------------|----------------------|----|---|------|-----|
|               | A              | A1   | B  | C  | D   | E    | F    | G  | H  | I  | J  | K  | L  | M  | N   | O    | P     |                             |                      | Q  | U | V    | X   |
| PFM52P8       | G1/8           | G1/8 | 18 | 27 | 85  | G1/8 | 13,5 | 14 | 30 | 13 | 41 | 26 | 33 | 16 | 4   | 35,5 | ∅ 3,3 | ∅ 3,3                       | 27                   | 28 | 2 | 630  | 100 |
| PF52P8        | G1/8           | G1/8 | 22 | 35 | 96  | G1/8 | 15,5 | 20 | 38 | 17 | 48 | 29 | 38 | 18 | 7   | 38   | ∅ 4,3 | ∅ 3,2                       | 30                   | 36 | 2 | 1240 | 160 |
| PF52P4        | G1/4           | G1/8 | 22 | 35 | 96  | G1/8 | 15,5 | 20 | 38 | 17 | 48 | 29 | 38 | 21 | 7   | 38   | ∅ 4,3 | ∅ 3,2                       | 30                   | 36 | 2 | 1040 | 160 |
| PFL52P4       | G1/4           | G1/4 | 27 | 40 | 115 | G1/8 | 17   | 24 | 50 | 20 | 58 | 33 | 46 | 22 | 6,5 | 46   | ∅ 4,3 | ∅ 4,3                       | 35                   | 45 | 2 | 1250 | 280 |
| PF52P3        | G3/8           | G1/4 | 27 | 40 | 115 | G1/8 | 17   | 24 | 50 | 20 | 58 | 33 | 46 | 24 | 6,5 | 46   | ∅ 4,3 | ∅ 4,3                       | 35                   | 45 | 2 | 1420 | 280 |
| PF52P2        | G1/2           | G1/2 | 34 | 50 | 144 | G1/8 | 16   | 28 | 72 | 27 | 72 | 36 | 54 | 36 | 8   | 58   | ∅ 5,5 | ∅ 4,3                       | 41                   | 63 | - | 3150 | 520 |

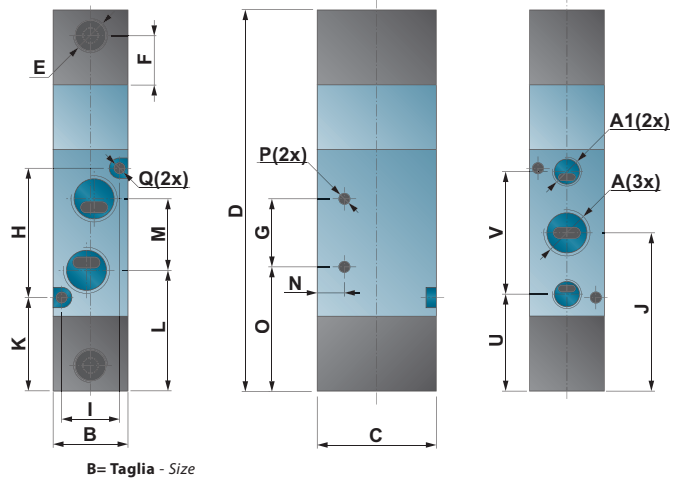
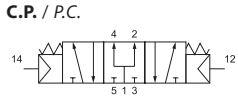
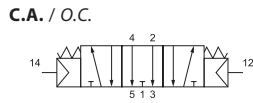
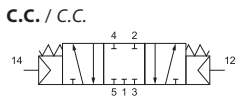
**VALVOLA A COMANDO PNEUMATICO 5/3 MONOSTABILE - PNEUMATIC OPERATED VALVE 5/3 MONOSTABLE**

B= Taglia - Size

| Codice - Code |             |             | Taglia<br>Size |      |    |    |     |      |      |    |    |    |    |    |    |    |     |    |       | Portata<br>Flow<br>(Nl/min) | Massa<br>Mass<br>(g) |    |   |      |     |
|---------------|-------------|-------------|----------------|------|----|----|-----|------|------|----|----|----|----|----|----|----|-----|----|-------|-----------------------------|----------------------|----|---|------|-----|
| C.C. / C.C.   | C.A. / O.C. | C.P. / P.C. | A              | A1   | B  | C  | D   | E    | F    | G  | H  | I  | J  | K  | L  | M  | N   | O  | P     | Q                           | U                    | V  | X |      |     |
| PFM53P8C      | PFM53P8A    | PFM53P8P    | G1/8           | G1/8 | 18 | 27 | 96  | G1/8 | 13,5 | 14 | 30 | 13 | 41 | 26 | 33 | 16 | 4   | 34 | Ø 3,3 | Ø 3,3                       | 27                   | 28 | 2 | 400  | 100 |
| PF53P8C       | PF53P8A     | PF53P8P     | G1/8           | G1/8 | 22 | 35 | 115 | G1/8 | 15,5 | 20 | 38 | 17 | 46 | 27 | 37 | 18 | 7   | 38 | Ø 4,3 | Ø 3,2                       | 30                   | 36 | 2 | 960  | 200 |
| PF53P4C       | PF53P4A     | PF53P4P     | G1/4           | G1/8 | 22 | 35 | 115 | G1/8 | 15,5 | 20 | 38 | 17 | 46 | 27 | 36 | 21 | 7   | 38 | Ø 4,3 | Ø 3,2                       | 30                   | 36 | 2 | 830  | 200 |
| PFL53P4C      | PFL53P4A    | PFL53P4P    | G1/4           | G1/4 | 27 | 40 | 134 | G1/8 | 17   | 24 | 50 | 20 | 56 | 31 | 45 | 22 | 6,5 | 45 | Ø 4,3 | Ø 4,3                       | 35                   | 45 | 2 | 910  | 320 |
| PF53P3C       | PF53P3A     | PF53P3P     | G3/8           | G1/4 | 27 | 40 | 134 | G1/8 | 17   | 24 | 50 | 20 | 56 | 31 | 44 | 24 | 6,5 | 45 | Ø 4,3 | Ø 4,3                       | 35                   | 45 | 2 | 1070 | 320 |
| PF53P2C       | PF53P2A     | PF53P2P     | G1/2           | G1/2 | 34 | 50 | 165 | G1/8 | 16   | 28 | 72 | 27 | 71 | 33 | 51 | 36 | 8   | 58 | Ø 5,5 | Ø 4,3                       | 41                   | 63 | - | 1550 | 520 |