

DMK 331

Industrial Pressure Transmitter

Ceramic Sensor

accuracy according to IEC 60770:
0.5 % FSO



Nominal pressure

from 0 ... 400 mbar up to 0 ... 600 bar

Output signals

2-wire: 4 ... 20 mA

3-wire: 0 ... 20 mA / 0 ... 10 V

others on request

Special characteristics

- ▶ pressure port G 1/2" flush for pasty and polluted media
- ▶ pressure port G 1/2" open port PVDF for aggressive media
- ▶ oxygen application





Optional versions

- ▶ IS-version
Ex ia = intrinsically safe for gases and dusts
- ▶ SIL 2
according to IEC 61508 / IEC 61511
- ▶ customer specific versions

The industrial pressure transmitter DMK 331 with ceramic sensor has been especially designed for pasty, polluted or aggressive media and for oxygen applications at low pressure range.

As with all industrial pressure transmitters made by BD|SENSORS, you may choose between various electrical and mechanical connections also on DMK 331.

Preferred areas of use are

-  Plant and machine engineering
-  Energy industry
-  Environmental engineering
(water - sewage - recycling)
-  Medical technology



Input pressure range ¹																		
Nominal pressure gauge [bar]	-1...0	0.4	0.6	1	1,6	2,5	4	6	10	16	25	40	60	100	160	250	400	600
Nominal pressure absolute [bar]	-	-	0.6	1	1,6	2,5	4	6	10	16	25	40	60	100	160	250	400	600
Overpressure [bar]	4	1	2	2	4	4	10	10	20	40	40	100	100	200	400	400	600	800
Burst pressure ≥ [bar]	7	2	4	4	5	7,5	12	18	30	50	75	120	180	300	500	750	1000	1100
Vacuum resistance	p _N ≥ 1 bar: unlimited vacuum resistance									p _N < 1 bar: on request								

¹ PVDF pressure port possible for nominal pressure ranges up to 60 bar

Output signal / Supply		
Standard	2-wire: 4 ... 20 mA / V _S = 8 ... 32 V _{DC}	SIL-version: V _S = 14 ... 28 V _{DC}
Option IS-protection	2-wire: 4 ... 20 mA / V _S = 10 ... 28 V _{DC}	SIL-version: V _S = 14 ... 28 V _{DC}
Options 3-wire	3-wire: 0 ... 20 mA / V _S = 14 ... 30 V _{DC} 0 ... 10 V / V _S = 14 ... 30 V _{DC}	

Performance	
Accuracy ²	≤ ± 0.5 % FSO
Permissible load	current 2-wire: R _{max} = [(V _S - V _{S min}) / 0.02 A] Ω current 3-wire: R _{max} = 240 Ω voltage 3-wire: R _{min} = 10 kΩ
Influence effects	supply: 0.05 % FSO / 10 V load: 0.05 % FSO / kΩ
Long term stability	≤ ± 0.3 % FSO / year at reference conditions
Response time	2-wire: ≤ 10 msec 3-wire: ≤ 3 msec

² accuracy according to IEC 60770 – limit point adjustment (non-linearity, hysteresis, repeatability)

Thermal effects (offset and span)	
Thermal error	≤ ± 0.2 % FSO / 10 K
in compensated range	0 ... 85 °C

Permissible temperatures	
Medium ³	-40 ... 125 °C
Electronics / environment	-40 ... 85 °C
Storage	-40 ... 100 °C

³ for pressure port in PVDF the medium temperature is -30 ... 60 °C

Electrical protection	
Short-circuit protection	permanent
Reverse polarity protection	no damage, but also no function
Electromagnetic compatibility	emission and immunity according to EN 61326

Mechanical stability	
Vibration	10 g RMS (25 ... 2000 Hz) according to DIN EN 60068-2-6
Shock	500 g / 1 msec according to DIN EN 60068-2-27

Materials	
Pressure port	standard: stainless steel 1.4404 (316 L) optional for G1/2" open port (for p _N ≤ 60 bar): PVDF others on request
Housing	stainless steel 1.4404 (316 L)
Option compact field housing	stainless steel 1.4301 (304); cable gland M12x1.5, brass, nickel plated (clamping range 2 ... 8 mm)
Seals	standard: FKM option: EPDM (for p _N ≤ 160 bar) others on request
Diaphragm	ceramic Al ₂ O ₃ 96 %
Media wetted parts	pressure port, seals, diaphragm

Explosion protection (only for 4 ... 20 mA / 2-wire)	
Approval DX19-DMK 331	IBExU 10 ATEX 1068 X / IECEx IBE 12.0027X stainless steel pressure port: zone 0: II 1G Ex ia IIC T4 Ga zone 20: II 1D Ex ia IIIC T135 °C Da plastic pressure port: zone 1: II 2G Ex ia IIC T4 Gb zone 21: II 2D Ex ia IIIC T85 °C Db
Safety technical maximum values	U _i = 28 V _{DC} , I _i = 93 mA, P _i = 660 mW, C _i ≈ 0 nF, L _i ≈ 0 μH, the supply connections have an inner capacity of max. 27 nF to the housing
Permissible temperatures for environment	in zone 0: -20 ... 60 °C with p _{atm} 0.8 bar up to 1.1 bar in zone 1 or higher: -40/-20 ... 70 °C
Connecting cables (by factory)	cable capacitance: signal line/shield also signal line/signal line: 160 pF/m cable inductance: signal line/shield also signal line/signal line: 1 μH/m

Miscellaneous		
Option SIL2 version ⁴	according to IEC 61508 / IEC 61511	
Option oxygen application	for $p_N \leq 25$ bar: O-ring in FKM Vi 567 (with BAM-approval); permissible maximum values are 25 bar / 150° C	
Current consumption	signal output current: max. 25 mA	signal output voltage: max. 7 mA
Weight	approx. 140 g	
Installation position	any	
Operational life	100 million load cycles	
CE-conformity	EMC Directive: 2014/30/EU	Pressure Equipment Directive: 2014/68/EU (module A) ⁵
ATEX Directive	2014/34/EU	

⁴ only for 4 ... 20 mA / 2-wire

⁵ this directive is only valid for devices with maximum permissible overpressure > 200 bar

Wiring diagrams

2-wire-system (current)

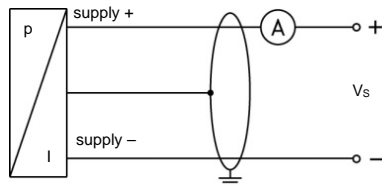

3-wire-system (current / voltage)

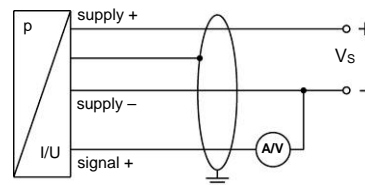

Pin configuration

Electrical connection	ISO 4400	Binder 723 (5-pin)	M12x1 / metal (4-pin)	compact field housing	cable colour (IEC 60757)
Supply +	1	3	1	V _s +	WH (white)
Supply -	2	4	2	V _s -	BN (brown)
Signal + (only for 3-wire)	3	1	3	S+	GN (green)
Shield	ground pin	5	4	GND	GYE (green-yellow)

Electrical connections (dimensions mm / in)

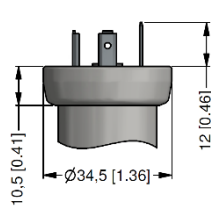

ISO 4400 (IP 65)

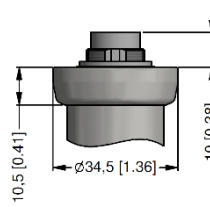

Binder Serie 723, 5-pin (IP 67)

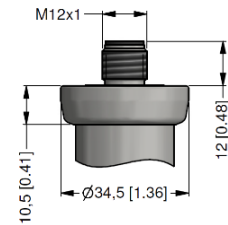

M12x1, 4-pin (IP 67)

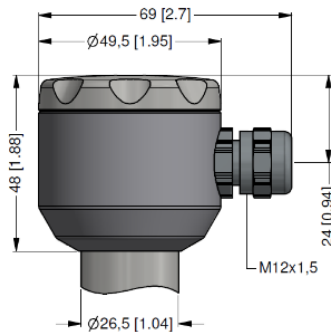

compact field housing (IP 67)

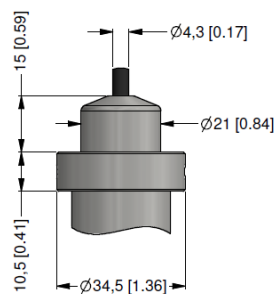

cable outlet with PVC-cable (IP 67) ⁶

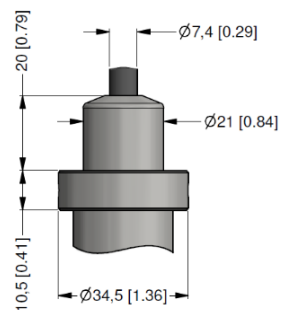

cable outlet, cable with ventilation tube (IP 68) ⁷

⇒ universal field housing stainless steel 1.4404 (316 L) with cable gland M20x1.5 (ordering code 880) and other versions on request

⁶ standard: 2 m PVC cable without ventilation tube (permissible temperature: -5 ... 70 °C)

⁷ different cable types and lengths available, permissible temperature depends on kind of cable

Dimensions (mm / in)

Standard

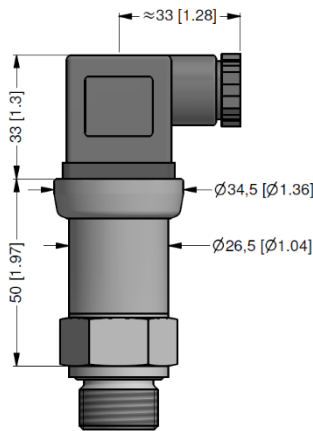

SIL- and SIL-IS version

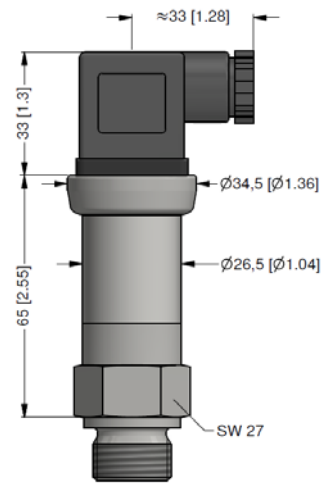

Mechanical connection (dimensions mm / in)

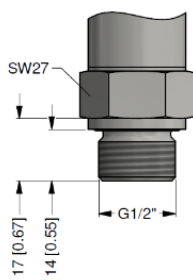

G1/2" DIN 3852

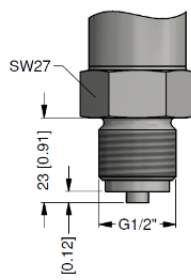

G1/2" EN 837

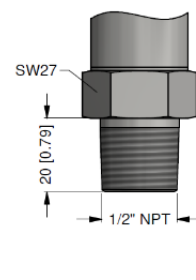

1/2" NPT

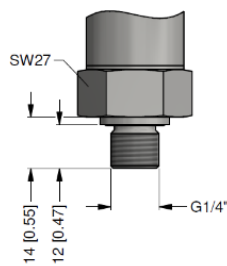

G1/4" DIN 3852

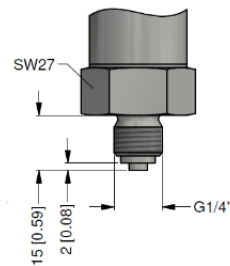

G1/4" EN 837

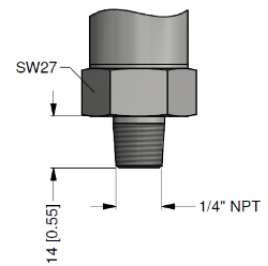

1/4" NPT

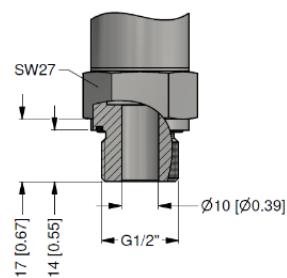

G1/2" open port DIN 3852

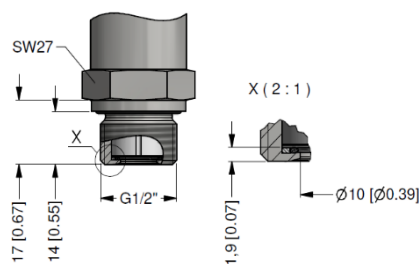

G1/2" semi-flush DIN 3852 ⁸

⇨ metric threads and other versions on request

⁸ possible for nominal pressure ranges $p_N \leq 60$ bar; absolute pressure ranges on request

